

PULNiX

TM-1020-15CL

AccuPiXEL Series



General Description

The TM-1020-15CL is a miniature, high-resolution monochrome progressive scan CCD camera. The imager resolution is 1008 x 1018 pixels and the frame rate is 15 frames per second. The interline transfer CCD permits full vertical and horizontal resolution of high speed shutter images. The electronic shutter has speed up to 1/16,000 sec. and can be reset asynchronously by external pulse control. The square imager format with uniform square pixels provides superior image definition in any orientation.

The TM-1020-15CL has a patent-pending, PULNiX exclusive, built-in look-up table (LUT). This full dynamic range-control function can be set at externally selectable knee slopes to optimize the CCD's full dynamic range in the normal output signal range.

Camera Link™ is a cable specification that includes data (8 bits) transmission as well as camera control and asynchronous serial communication all on a single cable. The Camera Link standard defines a single connector for both the frame grabber and camera end, and ensures that all Camera Link products are interchangeable with each other.

The TM-1020-15CL has a pixel clock locking phase lock loop (PLL) for multi-camera operation which requires exact data and clock phases from each camera (optional).*

Applications for the TM-1020-15CL include machine vision, medical imaging, intelligent transportation systems, high-definition graphics, gauging, character recognition, documents archiving, and surveillance.

Integration

The CCD imager of the TM-1020-15CL can be exposed for longer than the normal scan timing of 1/15 sec. This integration feature provides extra sensitivity for dark-environment applications. The progressive-scan imager permits a full frame of resolution in non-interlace format. Integration is achieved by controlling pin #11 of the 12-pin connector to low (GND).

Asynchronous Reset

The TM-1020-15CL's asynchronous reset is flexible and accepts external horizontal drive (HD) for phase locking. When the VINIT pulse is applied, it resets the camera's scanning and purging of the CCD. There are three modes to control the asynchronous reset and shutter speed:

- 1 External VINIT with pulse width. The duration between pulse edges controls the shutter speed externally.
- 2 Internal shutter speed with Fast mode. The video signal has no delay from the reset timing (shutter speed range is 1/2,000 to 1/16,000 sec.)
- 3 Internal shutter speed with Slow mode. The speed control varies from 1/125 to 1/1,000 sec. The video signal starts with internal V reset timing related to shutter speed.

Product Summary

- High resolution, high-speed 1" progressive scan 1008(H) x 1018(V) interline transfer CCD imager
- Miniature 44x64x44 mm housing with high-rel connector
- Digital Camera Link output or analog output
- 15 frames per second
- Maximum dynamic range control with exclusive, patent-pending built-in look-up table (Gamma, knee, user parameters)
- Full frame integration, two-row binning (1008 x 508) pixels
- Full-frame shutter to 1/16,000 sec.
- Asynchronous reset with external shutter control
- LVDS Camera Link external control

Electronic Shutter

The TM-1020-15CL has a substrate drain-type shutter mechanism which provides a superb picture at various speeds without smearing. A built-in manual shutter speed control selects the electronic shutter rate of 1/60 (non-async mode only), 1/125, 1/250, 1/500, 1/1,000, 1/2,000, 1/4,000, 1/8,000, or 1/16,000 second.

The CCD discharges at a high VINIT of 5V DC. With a negative pulse to VINIT, the camera resets and purges the charge momentarily. Then it starts integrating for the period of preset shutter control time by either an external pulse width or internal shutter control.

Progressive scanning permits a full 1000 lines of vertical resolution, as compared to a conventional CCD camera which captures only half the vertical lines per shutter.

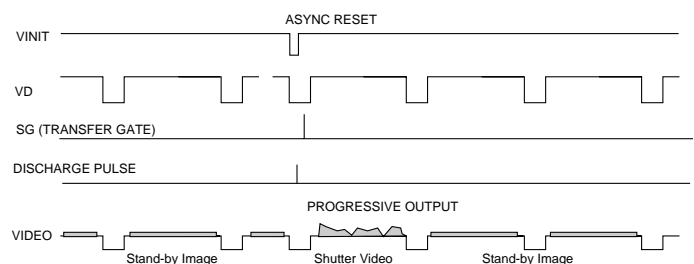

*With Camera Link output.

TM-1020-15CL

AccuPiXEL Series

patent pending

TM-1020-15CL Progressive Scan High-Resolution Shutter Camera

Dynamic Range Control

Typical interline transfer CCDs have fixed noise levels based on dark current (thermal or KT noise), pattern noise, and operating clock speed. Typically for a 1k x 1k CCD operating at 20MHz pixel clock, the noise level is around 30 electrons. The maximum capacity of the CCD charges is limited by the well capacity at saturation. The range is limited by the structure and the pixel size.

The TM-1020-15CL uses a 1" CCD with 9.0 μm x 9.0 μm pixel and two-phase vertical shift register structure. The well capacity is 50,000 electrons. The theoretical dynamic range is 50,000:30 = 1667:1 (64 dB).

A typical CCD camera does not use the full dynamic range due to the nominal gain and the output specification such as RS-170. The typical CCD camera has its gain set at 16 to 22 dB and the RS-170 video level is 714 mV. Using 20 dB gain for the calculation, CCD output is limited to 714/10 = 71.4 mV. Since the CCD's saturation voltage is 400 mV to 500 mV, it uses less than 1/5 of the full dynamic range.

Machine vision and outdoor applications cannot afford to miss image information behind the saturation, which is why the dynamic range adaptation is critical.

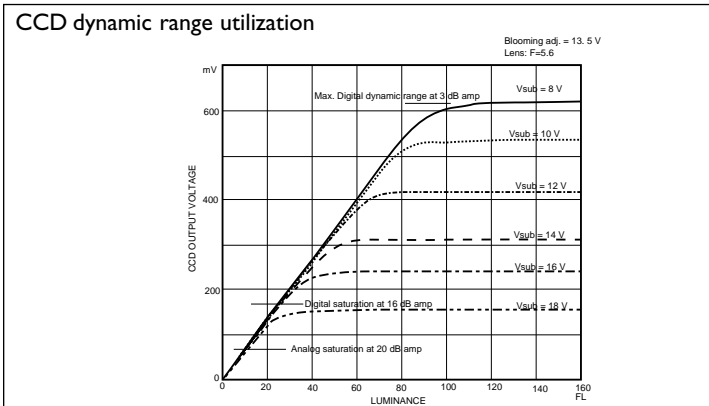

Programmable LUT and Knee Control (patent pending)

The TM-1020-15CL has a built-in LUT (look-up table) for dynamic range control. At a specific gain setting, the offset (minimum level... dark point) and A/D reference top voltage (maximum level... saturation point) are set to 10-bit A/D input so that full dynamic range of CCD is utilized at 10-bit references as the input and the LUT output is converted into 8-bit to adjust the gamma correction.

The look-up table has two knee points (variable gamma selection) that allow the 10-bit to be segmented into three regions. The look-up table selection can be made either by variable knee curve or by direct input.

Scan Mode

Full Progressive Scan

Normal scanning mode for the TM-1020-15CL is 1008 x 1018 pixels. The standard speed with single-channel output is 15 frame/sec at the pixel clock of 20 MHz. Unlike an interlace scan camera, the TM-1020-15CL reads every line from top to bottom,

resulting in all lines being obtained per captured image frame with electronic shutter.

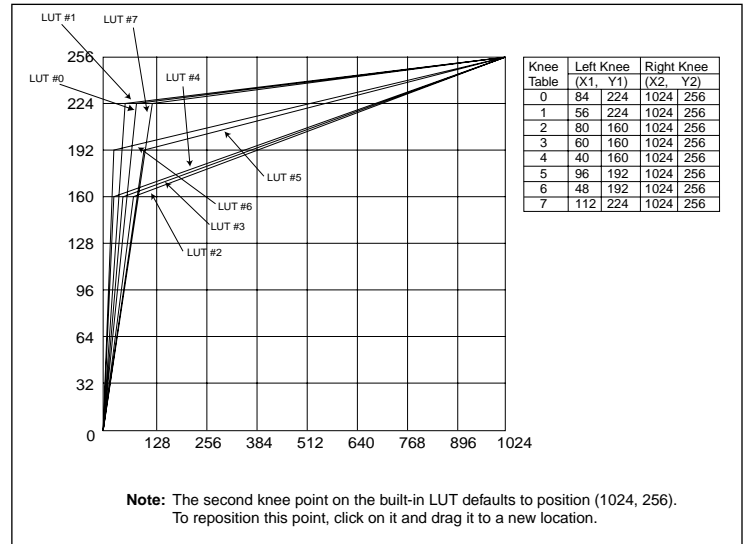

Two-Row Binning

This is a standard feature in the TM-1020-15CL. The camera scans two rows together and outputs 1008 (H) x 508 (V) pixels at 30 frames per second. Two-row binning is typically implemented to increase speed.

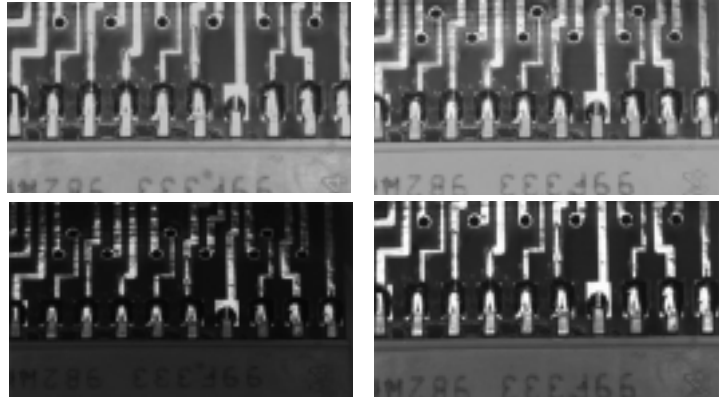

Linear image: When PCB surface is visible, metal trace is saturated. If the metal surface appears, then the plastic surface is too dark.

Knee-controlled image: The upper is LUT#6, the lower is #7. Both show the full dynamic range with different effects.

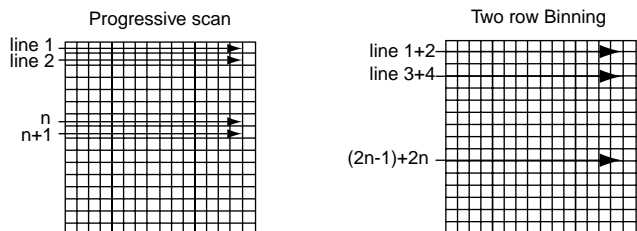

TM-1020-15CL Progressive Scan High-Resolution Shutter Camera

External Sync

The TM-1020-15CL accepts an external sync. of standard HD and VD at TTL level for general locking to a system sync. and clock. The external sync. is only available for 15-frame mode and the frequency requirement is as follows:

$$f_{HD} = 15.734 \text{ KHz} \pm 5\%$$

$$f_{VD} = 15.00 \text{ Hz} \pm 5\%$$

Internal Master clock = 40.00 MHz,

Pixel clock = 20.00 MHz

Please contact PULNiX for TM-1020-15CL timing charts.

Pixel Clock Locking*

For multiple-camera applications such as 2D or 3D measurement, a parallel digital data input capability is important. The high resolution and precision measurement requires that camera data be consistent and free from phase lock loop (PLL) jitter. This is especially important for digital output multiplexing.

The TM-1020-15CL has an optional capability for pixel clock locking. It takes RS-422 (differential) external clock and H and V reset sync (TTL or RS-422). By doing this, each camera's digital data is in-phase with the pixel clock (data clock) for multiplexing or parallel input to a frame grabber.

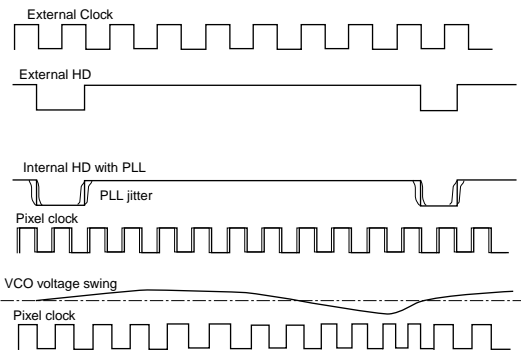

Connector and Pin Configurations

Camera Link Connector

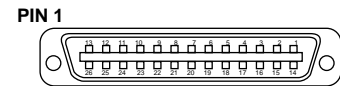

MDR 26-pin connector (0226-622VC)

Pin#	Description
1	GND (Shield)
2	X0-
3	X1-
4	X2-
5	Xclk-
6	X3-
7	SerTC+
8	SerTFG-
9	CC1-
10	CC2+
11	CC3-
12	CC4+
13	
14	GND (Shield)
15	X0+
16	X1+
17	X2+
18	Xclk+
19	X3+
20	SerTC-
21	SerTFG+
22	CC1+
23	CC2-
24	CC3+
25	CC4-
26	GND (Shield)

12-Pin Connector

- 1 GND (power)
- 2 +12V
- 3 GND (analog)
- 4 Video out
- 5 GND (digital)
- 6 VINIT in
- 7 VD in
- 8 Strobe+ out
- 9 HD in
- 10 RXD*
- 11 Int. cont
- 12 TXD*

* Optional TTL serial communications

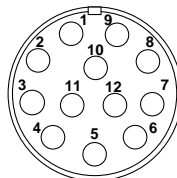

Camera Link Signal Assignment to Channel Link Chip

Tx IN0	Data A0 (LSB)
Tx IN1	Data A1
Tx IN2	Data A2
Tx IN3	Data A3
Tx IN4	Data A4
Tx IN5	Data A7 (MSB)
Tx IN6	Data A5
Tx IN7	
thru	N/C
Tx IN23	
Tx IN24	LDV
Tx IN25	FDV
Tx IN26	N/C
Tx IN27	Data A6

